

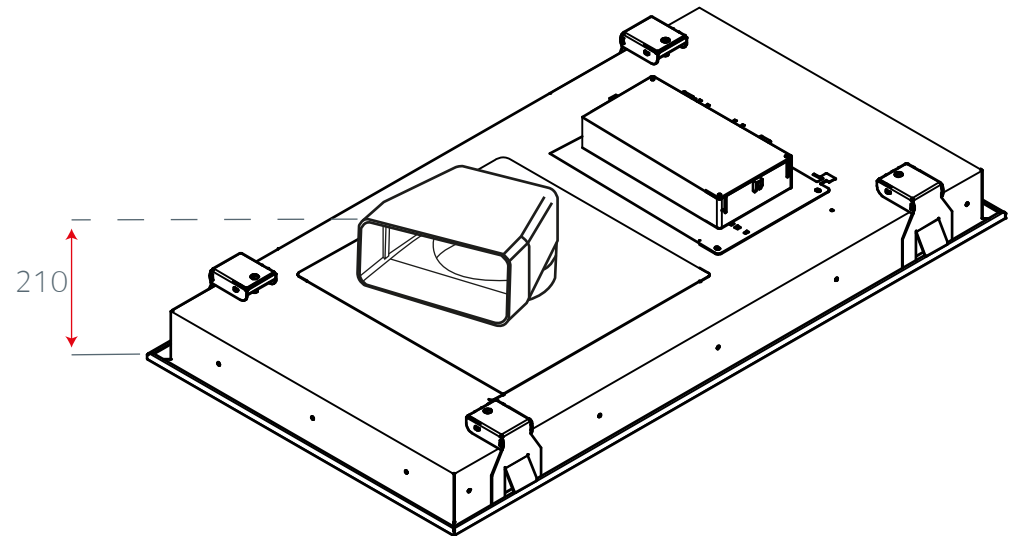

LUXAIR™
EXTRACTION WITH ATTRACTION

LA-90-Tolvi External Motor

6" - 220 x 90 Ducting

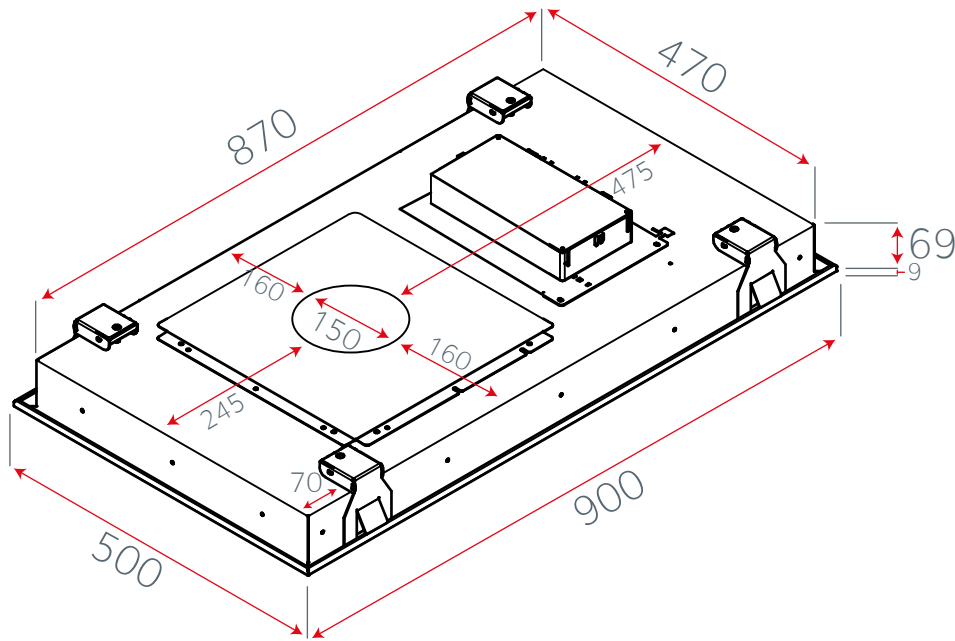
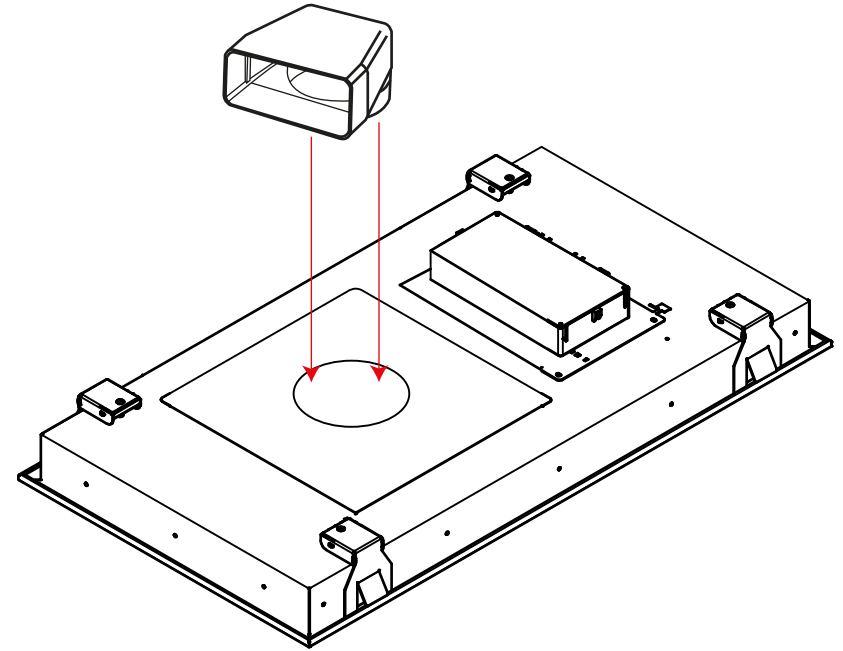
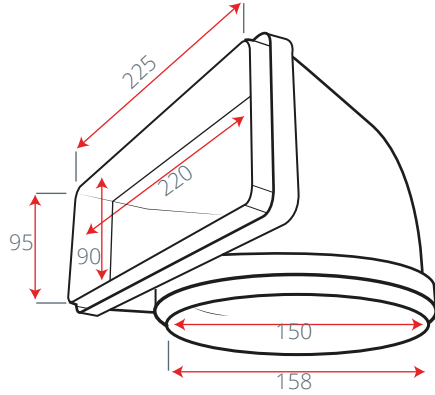

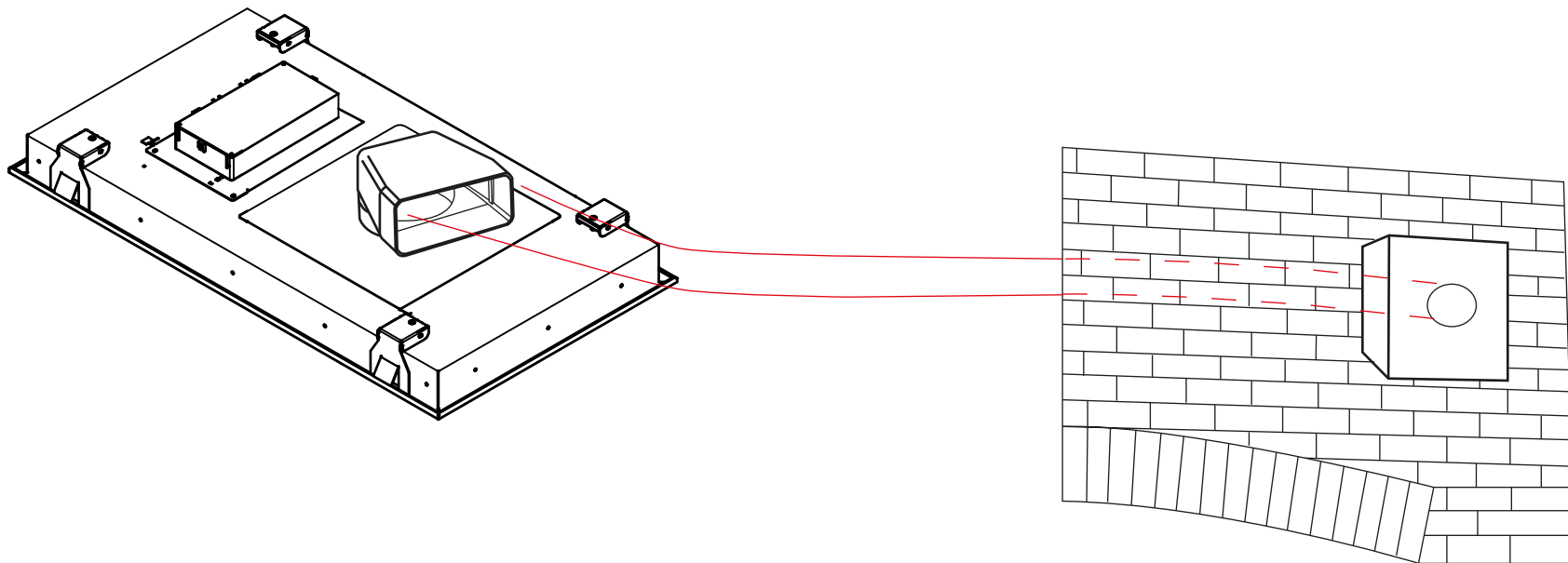

Wall Mounted External Motor

Pitched Roof External Motor

Flat Roof External Motor

